

School	Candidate's Name (PLEASE PRINT)
---------------	--



WINCHESTER
COLLEGE

Entrance Examination

SCIENCE 2023

Total time allowed: 1 hour 30 minutes

This paper is divided into **THREE** sections.

- Section A Physics
- Section B Biology
- Section C Chemistry

Each section carries 30 marks.

The mark for each question is given in brackets [].

All sections are composed of a number of short answer questions.

Candidates should attempt **ALL** the questions in these sections, answering in the spaces provided on the question paper. Calculators may be used.

Candidates will be penalized for giving answers to too many significant figures.

SECTION A - PHYSICS

A1 Monty would like to add some lighting to his garden. He sets up the series circuit shown below.

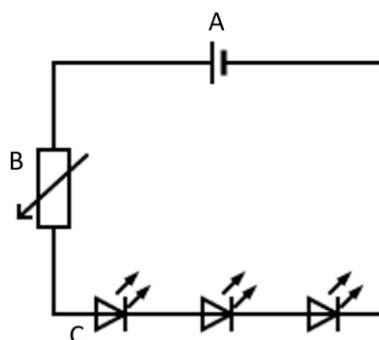

(a) State the name of each of the components.

A:

B:

C:

[3]

(b) Suggest a reason why component B has been included in the circuit.

.....

.....

[1]

(c) After he builds the circuit Monty finds that the lights are never bright enough.

(i) He decides to measure the current using an ammeter. Add an ammeter to the diagram to measure the current through component B.

[2]

- (ii) An image of the ammeter is shown below. State the reading on the ammeter. Give an appropriate unit.

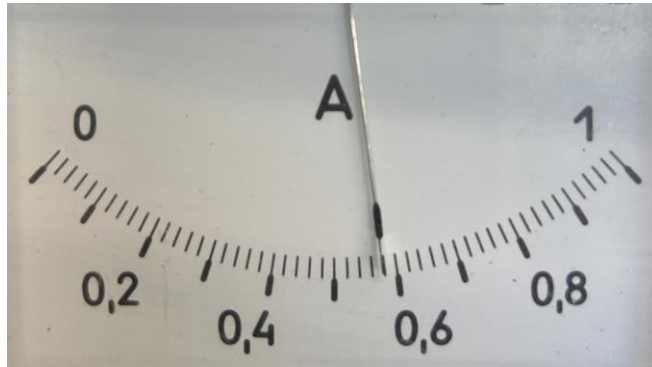

Reading: Unit: [2]

- (iii) Suggest two alterations that Monty could make to the circuit to increase the size of the current.

Suggestion 1:

.....

Suggestion 2:

..... [2]

- (d) Monty's friend, Alan, suggests that Monty should use a different circuit. He suggests:

- connecting the three component Cs in parallel
- including a **switch** that is able to turn on and off all the components simultaneously.

Draw a circuit diagram using Alan's suggestions.

[3]

- (e) A simpler circuit might only contain a single cell and a single bulb. Describe the energy stores and pathways (or processes) present in this circuit.

.....
.....
.....

[3]

- A2 A geologist sets up an experiment to measure the rate at which water is dripping from some rocks in a cave. She places a measuring cylinder under the source of the drops, and leaves it in place for 3.0 minutes. An image of the measuring cylinder after 3.0 minutes is shown below.

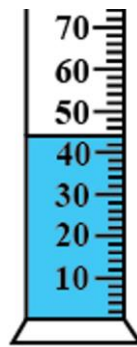

- (a) The measuring cylinder markings are in cm³. State the reading shown on the measuring cylinder.

..... cm³ [1]

- (b) The geologist is interested in finding the density of the water. She measures the mass of the measuring cylinder with the water in it.

- (i) Explain why this measurement will not allow the geologist to calculate the density of the water.

.....
.....

[1]

- (ii) Describe the method the geologist should use to measure the density of the water. You may use a diagram to support your answer.

.....

.....

.....

.....

.....

.....

[3]

- (c) When she uses the correct method, the geologist finds that the water has a density of 1.02 g/cm^3 . The geologist wishes to collect 1.00 kg of the water for further testing.

- (i) Show that the volume of 1.00 kg of water of density 1.02 g/cm^3 is 980 cm^3 .

[2]

- (ii) Calculate the time the geologist will need to leave the apparatus to collect 1.00 kg of water.

[2]

(d) The geologist plans to record the time it takes to collect 1.00 kg of water in the cave each day for one week. In the space below, construct a results table that the geologist could use to record this information.

[3]

(e) The geologist observes that on the first Monday, Tuesday and Wednesday the time to collect 1.00 kg of water is significantly less than on the other days of the week. She concludes that the rate of flow of water is always faster at the start of the week. Comment on this observation and conclusion.

Observation:

.....

.....

Conclusion:

.....

[2]

End of Section A

School	Candidate's Name (PLEASE PRINT)
---------------	--

SECTION B – BIOLOGY

B1 A student investigated the effect of light intensity on a photosynthesising plant (pondweed). They used the apparatus shown below.



distance
↔

(a) When the light was switched on, bubbles appeared in the beaker. State the word equation for the reaction that is responsible for the production of the bubbles.

..... [1]

(b) The student carried out an experiment by varying the light intensity by changing the distance of the lamp from the beaker carrying the pondweed and counting the number of bubbles produced by the plant in one minute. Name one variable that the student should control (keep constant), and suggest a way the student might do this.

Variable: [1]

Method to keep constant:

..... [1]

(c) The student collected the following data:

Distance in cm	Number of bubbles per minute
10	84
15	84
20	76
40	52
50	26

Complete a graph below using the data from the table above.

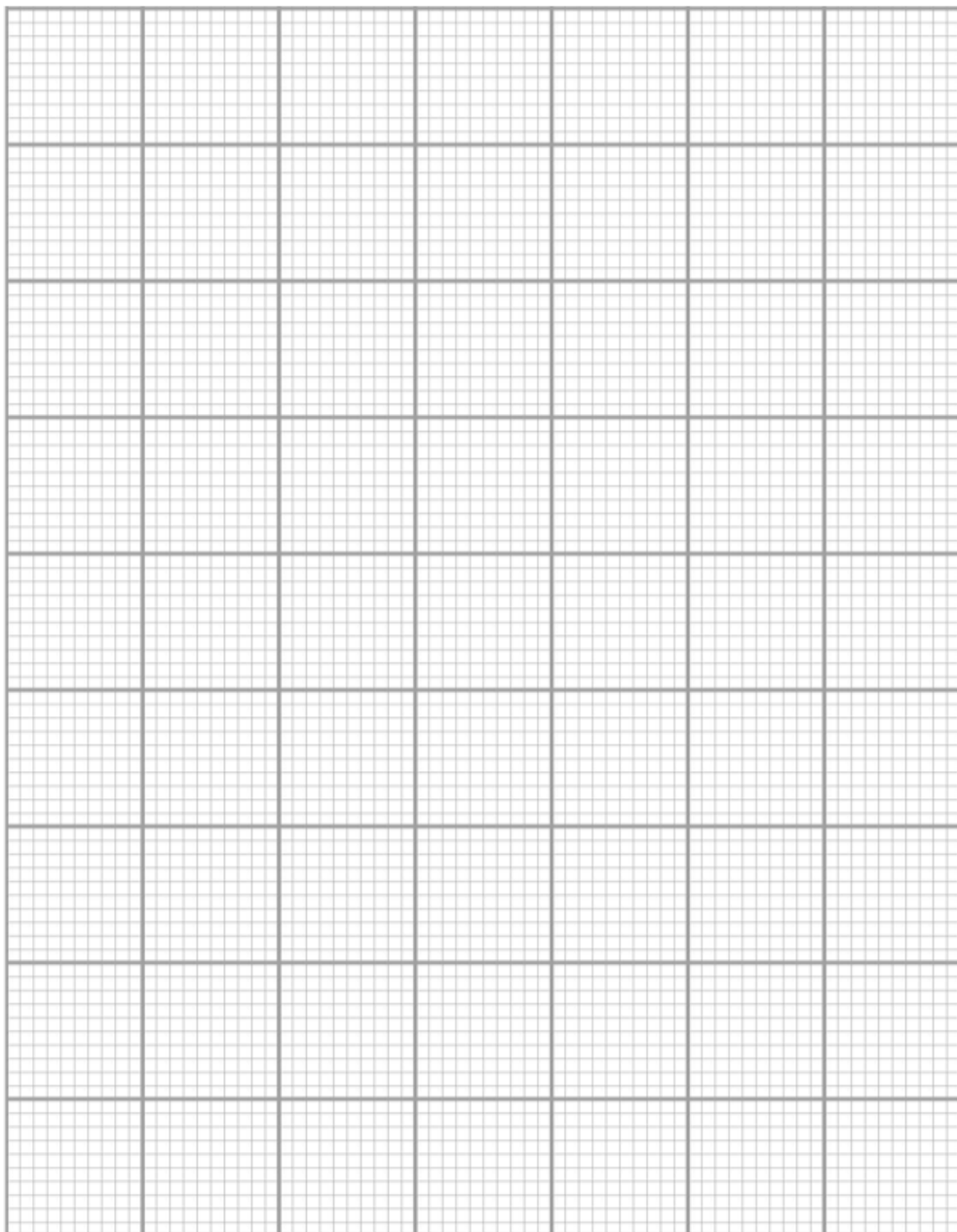

[5]

(d) The student concluded that the closer the lamp was moved towards the pondweed, the greater the rate of photosynthesis. Explain whether you think they are correct. Give reasons to support your answer.

.....

 [3]

(e) Describe one change to the method that would improve the reliability of the student's results.

..... [1]

B2 Frankie looked at three cells under a microscope. All the cells are different sizes: one bacterial cell, one liver cell, and one plant cell from the mesophyll of a leaf.

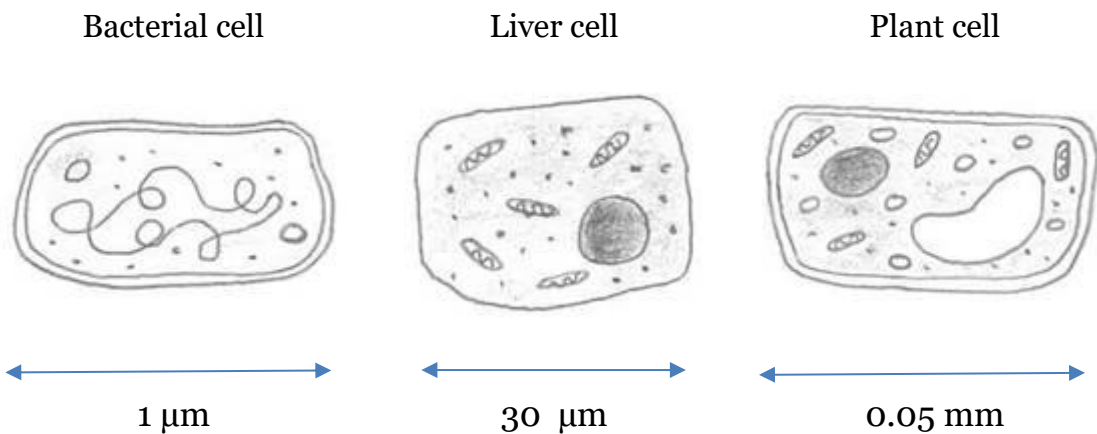

There are 1000 micrometres (μm) in one millimetre (mm)

(a) Give two similarities between the liver cell and the plant cell.

1
 2 [2]

(b) State which is the largest of these cells.

..... [1]

(c) Label the cell membrane on the plant cell, and describe its function.

.....
..... [2]

(d) Suggest how the vacuole and cell wall of plant cells work together to allow plants to grow upright.

.....
.....
..... [3]

(e) Bacterial cells can cause disease in humans. Name one disease caused by bacteria, and suggest a precaution that Frankie should take when using the microscope.

Name of disease:

How to prevent infection:

..... [2]

B3 The diagram below shows the typical structure of a flower.

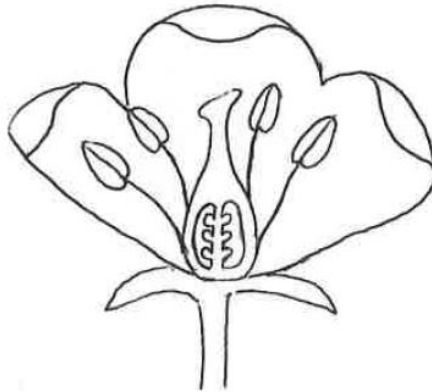

(a) Label the diagram above with the letter X to show the site of pollen production.

[1]

(b) With reference to the diagram, explain whether you think this plant is wind pollinated or insect pollinated.

.....
.....

[3]

(c) Explain what is meant by the term *fertilisation* in flowering plants.

.....
.....

[3]

(d) Suggest one advantage of a seed being dispersed far away from the plant that produced it.

.....
.....

[1]

End of Section B

BLANK PAGE

School	Candidate's Name (PLEASE PRINT)
---------------	--

SECTION C - CHEMISTRY

- C1 Select from the options below the technique which is best for separating pure water from a solution of copper(II) sulphate in water.
- A distillation
 - B decanting
 - C chromatography
 - D filtration
- [1]
- C2 Select the statement below which is **incorrect**.
- A a glowing splint is used to confirm the presence of hydrogen gas
 - B limewater is used to confirm the presence of carbon dioxide gas
 - C oxygen gas rekindles the dying embers of a fire
 - D salt water at room temperature and pressure boils below 100°C
- [1]
- C3 Select the option below which correctly describes the arrangement of particles in water.
- A the particles only vibrate
 - B the particles do not move
 - C the particles have no gaps between them
 - D the particles move randomly
 - E the particles have a regular arrangement
- [1]

C4 A kitchen accident involving a dropped jar of sugar produces a mixture of crushed glass, sugar and water. The mixture is filtered. Select the option which correctly lists the component(s) found in the filtrate.

- A water
- B sugar
- C glass
- D glass and water
- E sugar and water
- F glass, sugar and water

[1]

C5 Select the statement below which is **incorrect**.

- A quicklime (calcium oxide) is used to treat alkaline soil
- B universal indicator solution is yellow at pH 5-6
- C carbon dioxide gas dissolves in water to give an acidic solution
- D a “roaring flame” is the term used to describe a Bunsen burner giving out a blue flame

[1]

C6 Select the statement below which correctly describes the behaviour of methanoic **acid**.

- A methanoic acid reacts with sodium hydroxide to give hydrogen gas and the salt sodium methanoate
- B methanoic acid turns litmus solution blue
- C methanoic acid has a pH of approximately 4
- D methanoic acid is a solid at room temperature and pressure

[1]

- C7 Calcium granules are added to dilute nitric acid in a beaker. Select the option below which best describes the observations.
- A there is no visible change but the temperature of the solution falls
 - B the granules disappear and the temperature of the solution falls
 - C the granules disappear to give a milky suspension
 - D the granules disappear, the temperature of the solution rises, bubbles of gas are produced, and the solution goes milky

[1]

- C8 Select, with a tick, the option with only correct chemical formulae.

			✓
A	lead Le	copper(II) sulfate Cu_2SO_4	
B	methane CH_4	copper(II) sulfate CuSO_4	
C	oxygen O_2	sodium hydroxide SoOH	
D	calcium carbonate CaCO_3	methane CH_3	

[1]

- C9 Select the option below which is an example of chemical change rather than physical change.
- A water forming as the product of operation of a hydrogen fuel cell
 - B the sublimation of iodine solid on heating
 - C the mass loss recorded on heating a beaker mixture of insoluble calcium carbonate and water
 - D the white to blue colour change observed when water is added to anhydrous copper(II) sulfate

[1]

C10 Iron metal is obtained industrially from its ore, haematite, using a blast furnace as pictured below.

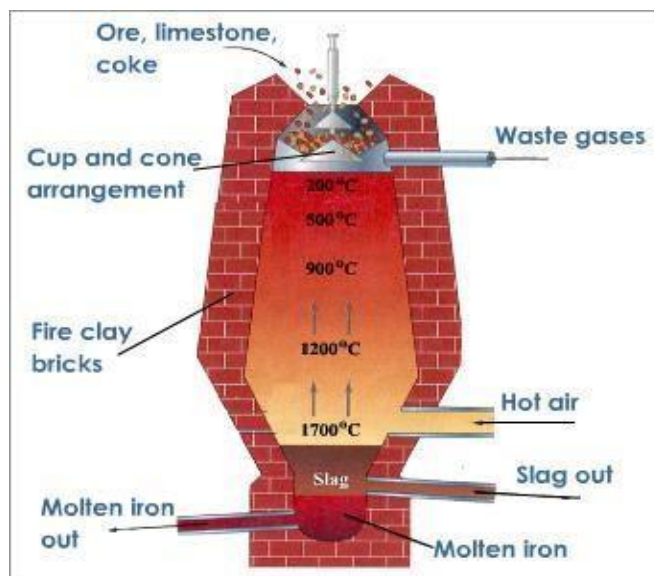
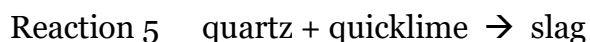
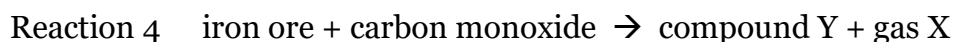
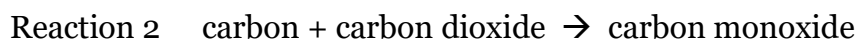
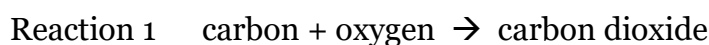

Image found at [Blast furnace - a chimney-like structure in which iron ores are converted into iron metal. Iron ore, coke, and limestone ... | Blast furnace, Furnace, Bethlehem steel \(pinterest.co.uk\)](#)

Read the information below, before attempting the questions that follow.

The industrial production of iron requires **four raw materials**: iron ore, air, coke, and limestone (a source of calcium carbonate). The iron ore is rarely pure, quartz (silicon dioxide) being the most common impurity. However, quartz reacts readily with quicklime (calcium oxide).

In the blast furnace the raw materials are heated and a sequence of reactions takes place to produce iron:



In the heat of the furnace the slag melts and floats on top of the molten iron.

(a) What is the chemical symbol for iron?

.....

[1]

(b) Deduce which of the raw materials the carbon in Reaction 1 comes from.
..... [1]

(c) Given that iron ore consists mainly of iron oxide, write a word equation to represent the reaction between iron ore and carbon monoxide. Include the real names of gas X and compound Y.
.....
..... [2]

(d) What does the diagram indicate about the comparative density of molten iron and molten slag?
..... [1]

C11 (a) A chemist took 8.00 g of potassium chloride and attempted to dissolve it in 20.00 g of water at 20°C. He filtered the resulting solution and found that 1.40 g of the solid had not dissolved.

Calculate the solubility of potassium chloride at 20°C in g of solid per 100 g of water.

.....
..... [2]

(b) The chemist carried out further experiments for both potassium chloride and potassium chlorate, two chemicals which behave differently in terms of their solubility. [8]

Plot the data in the table overleaf on the grid below it and include your answer to (a) in the graph. **You should put temperature on the x-axis and solubility on the y-axis and use appropriate choices of scale.**

Temperature (°C)	0	20	40	60	80	100
solubility of potassium chloride (g per 100 g of water)	28.0		38.0	43.0	48.0	53.0
solubility of potassium chlorate (g per 100 g of water)	4.0	7.5	19.0	25.0	41.0	59.0

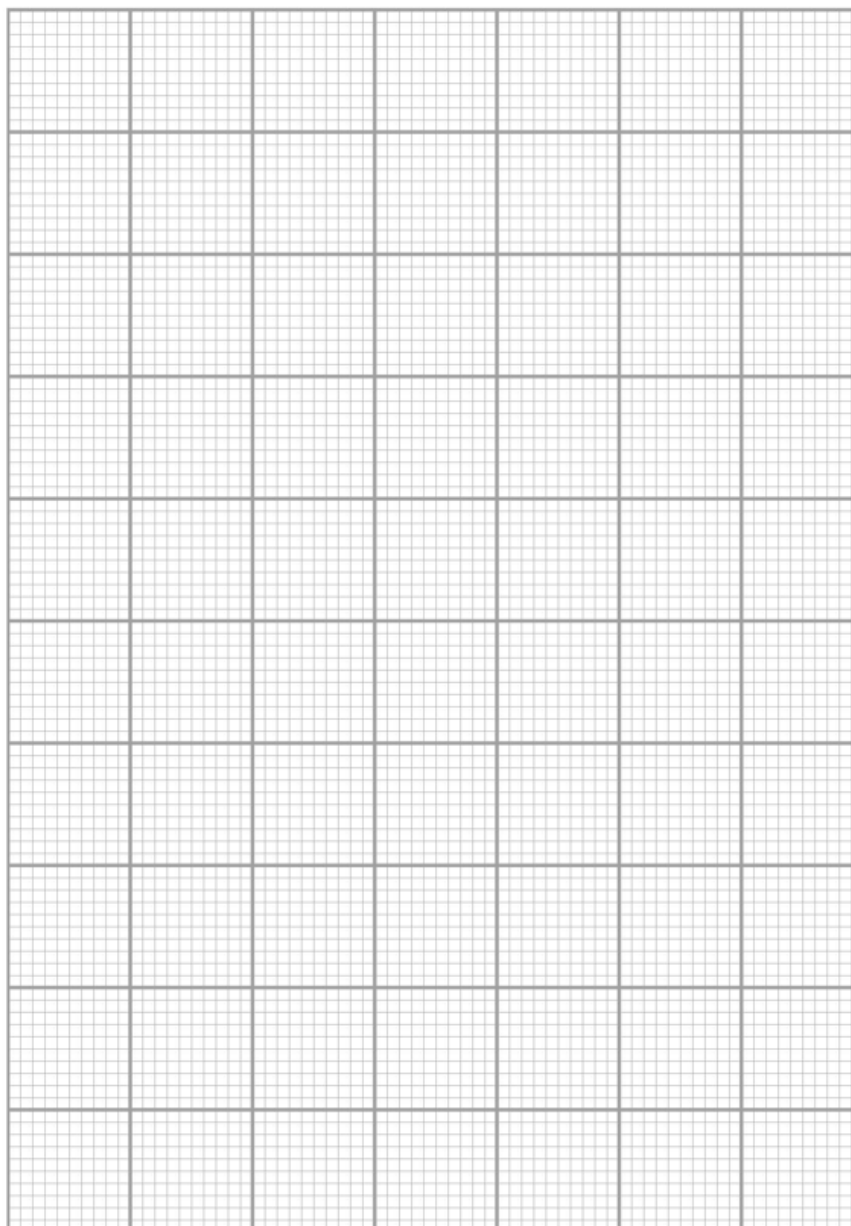

(c) Identify the anomalous result in the potassium chlorate data.

..... [1]

(d) Use your graph to find the temperature at which potassium chloride and potassium chlorate have equal solubility. You should show your working clearly on your graph.

..... [2]

C12 A piece of iron wool is placed in a graduated glass tube, which is left in a beaker of water. After several days, the water level in the tube changes.

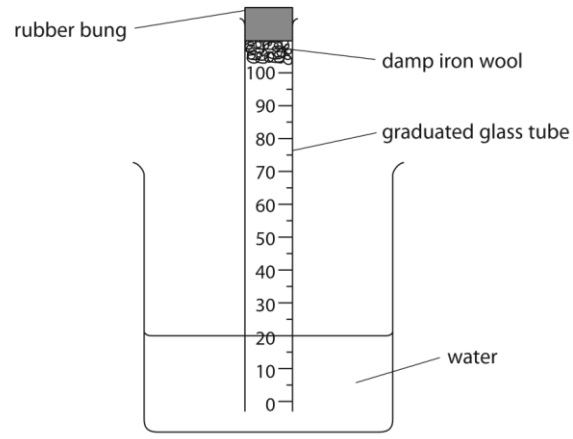

One set of results obtained by such a method were:

- volume of air in tube at start = 80.0 cm³
- water level reading at start = 21.0 cm³
- water level reading at end = 33.5 cm³

(a) Calculate the percentage of oxygen in air based on this experiment.

..... [1]

(b) State how your value from (a) compares with that for most samples of air.

.....
 [1]

(c) Suggest an explanation for your answer to part (b).

.....
 [1]

End of Section C

